

MAP PROTOCOL

Omnichain Layer of Web3

with Provably Secure Cross-chain Communication

Built upon **Light-client** and **Zero-Knowledge** technology

Litebook v4

mapprotocol.io

Background

Three stages of crypto industry development

The birth of the Bitcoin peer-to-peer e-cash payment system created the crypto industry and stimulated the development of centralized exchanges (CEXs) since 2009.

The emergence of the programmable smart contract of Ethereum boosted the development of public chains and decentralized applications (dApps) since 2015.

Omnichain network infrastructure makes omnichain dApps possible and significantly boosts development.

Major cross-chain solutions in the crypto industry

CEXs:

- Centralized
- Non-interoperable

Solutions of Centralized Security:

- Cross-chain bridge dApps with MPC super administrator
- Oracle verification mechanism with ambiguity and collusion risk
- The transitional solution in MPC with PoS. (Slightly better than pure MPC)
- Optimistic roll-up with long verification waiting time
- Light-client verification mechanism with ultra-high gas fees during cross-chain among heterogeneous chains

Polkadot & Cosmos' Solution:

- It is difficult for the EVM and other heterogeneous chains to connect the cross-chain network through SDK.
- The relay chain is dedicated to blockchain mainnet developers instead of cross-chain dApp developers.
- Although Thorchain is Cosmos's ecosystem chain, the cross-chain mechanism of Thorchain is still MPC.
- Polkadot has not yet developed any cross-chain applications.

MAP Protocol History

2019: the core team was founded.

- With the mission of constructing a cross-chain peer-to-peer e-cash payment system infrastructure, a team of senior blockchain research experts, experienced smart contract developers, and bottom-layer blockchain engineering experts started to build MAP Protocol. The MAPO team deeply agrees with the classic Satoshi Nakamoto's doctrine of blockchain and believes that cross-chain technology should not deviate from it and should contribute to a trustful peer-to-peer blockchain universe.

2020: MAP Protocol v1.0 released - a cross-chain solution **with light-client verification and without relay chain**.

- Version 1.0 was based on an in-depth study of Cosmos and Polkadot - from their design architecture to underlying codes. Research continues on technologies including MPC (Multi-Party Computation), Rollups, Light-Client, Oracle, and cross-chain messengers.
- Version 1.0 was consisted of **Relayer** for transferring cross-chain messages, and **Light-client** providing cross-chain verification finality without a relay chain. However, when Light-client conducted cross-chain verification between heterogeneous chains, the level of complexity and difficulties increased dramatically, and a tremendous amount of gas fees were consumed, which made Version 1.0 only applicable theoretically.

2021: MAP Protocol v2.0 was developed - **light-client + relay chain** - The omnichain network for an interoperable Web3

With more top experts joined in 2021, the MAPO team began to develop the current version - MAP Protocol v2.0:

- Similar technical components as Cosmos and Polkadot: cross-chain communication components, relay chain, and Light-client.
- Unlike Cosmos and Polkadot, MAP Protocol creates omnichain network by proactively deploying on-chain and inter-chain cross-chain communication components.
- By adding EVM and heterogeneous chains' signatures, hashes, mining, and Merkle proof calculation to the EVM level of **MAPO Relay Chain**, the gas cost consumed by Light-client's heterogeneous cross-chain verification is optimized. (One transaction, one verification)
- By providing Turing completeness in the MAPO Relay Chain, developers can directly deploy omnichain applications on MAP Protocol.
- Support omnichain data, fungible tokens, and NFTs.
- The omnichain covers all chains no matter they are EVM chains or heterogeneous chains.
- Provide MAPO Services (MOS), like Google Mobile Services, to facilitate the convenient deployment for omnichain dApp developers.

The **4-year** development journey was filled with trial & error and frustrations, but MAPO Team adhered to the mission to develop a cross-chain peer-to-peer e-cash payment system infrastructure. MAPO team now proudly announces that MAP Protocol is the **provably secure omnichain network infrastructure** that **outranks all the existing cross-chain solutions in blockchain space** - **security-finality, all-chain coverage, instant confirmation, minimum cost, and developer-ready**.

Introduction

- MAP Protocol is the omnichain layer of Web3 for dApps with provably secure cross-chain communication built on **light-client** and **zero-knowledge technology**, with five advantages:

Security finality	Cost-efficient	Wide chain coverage	Instant confirmation	dApp Developer ready
Best-in-class blockchain-level security via independent self-verification cross-chain verification network with light-client and zk technology .	No additional cost for cross-chain transactions other than gas fees. By zk technology , gas fee is further reduced to minimum.	Extends EVM layer of MAPO Relay Chain with pre-compiled smart contracts of public chains to seamlessly connect both EVM & non-EVM chains .	Confirms cross-chain transactions instantly. Confirmation speed for cross-chain transactions is only limited by each chain's block time .	Effortless integration via SDKs for straightforward omnichain app deployment.

- Nowadays, general chains, such as Ethereum, Avalanche, Flow, have their own respective territory; and dedicated chains, such as IoTex, NKN, are also thriving. Omnichain network, an infrastructure to connect them all, is the future. Together with worldwide developers, MAP Protocol is the dawn of a new omnichain age.

MAP Protocol vs. Alternatives

	 MAP PROTOCOL	<u>Cosmos</u> & <u>Polkadot</u>	<u>LayerZero</u>	<u>Axelar</u>	<u>Celer</u>	<u>Multichain</u>	<u>Thorchain</u>
Security	Decentralized security (Light-Client & zk)	Decentralized security (Light-Client)	- Result of oracle is ambiguous - Collusion risks (relayer & oracle)	Centralized security (MPC/Multi-Party Computing)			
Cross-chain Confirmation*	Instant	Instant		Delay			
Target Audience	Omnichain dApps	Mainnet developers	Cross-chain dApps		End Users		
Chain coverage	EVM & Non-EVM	Chains inside each system	Mainly EVM	EVM & Non-EVM			
Gas fee	Low (dApps)	Low (Mainnets)	Low (End users)				
Developer support	SDK/Shared Vaults/Data smart contracts	Partial or no support to dApp developers					

* MAP Protocol's cross-chain infrastructure is implemented both **on-chain**, **inner-chain** and **inter-chain**.

Technical Mechanism Summary

While cross-chain bridges can be easily built with MAP Protocol, MAP Protocol itself tackles a more fundamental problem and pursues a larger vision: boosting the whole cross-chain ecosystem by **building an omnichain network infrastructure**. Any dApp built with the infrastructure **automatically inherits the omnichain nature of MAP Protocol** without requiring the developers to tackle the error-prone cross-chain communications. With the technical threshold of building omnichain dApp reduced, the ecosystem shall thrive.

1. MAP Protocol is structured in **three layers**: Protocol Layer, Omnichain Services Layer (MOS), and Application Layer.
2. MAP Protocol achieves omnichain interoperability with all **EVM and non-EVM chains** by deploying cross-chain execution and verification via on-chain smart contracts, and cross-chain messenger inter-chain program.
3. MAP Protocol's cross-chain verification network has security finality by adopting the **Light-client** independent self-verification mechanism and **zk-SNARK**. With MAPO, EVM and non-EVM chains form a cross-chain execution and verification network.
4. MAPO Relay Chain is fully EVM compatible built upon **Proof-of-Stake** mechanism and **Byzantine Fault Tolerant** consensus.
5. MAPO Relay Chain accomplished heterogeneous expansion on the EVM level, which simplified the complexity of engineering and minimized the gas fee for cross-chain verification between heterogeneous chains.
6. MAP Protocol provides **SDKs** to dApp developers. **dApps do not need to deploy on MAPO Relay Chain** in order to connect to MAP's omnichain network.
7. MAP Protocol provides developers with MAP Omnichain Service (MOS) similar to Google Mobile Services. It is convenient for developers to develop and share omnichain asset liquidity and data. Each dApp can also have its own Messenger and tailor-make their reward scheme.
8. MAP Protocol supports both **assets and data cross-chain**.
9. MAP Protocol supports the development of all omnichain dApps, including omnichain oracle, omnichain swap, cross-chain bridge for tokens and NFTs, decentralized derivatives, omnichain DAO, and omnichain GameFi, etc.

MAP Protocol - Technical Overview

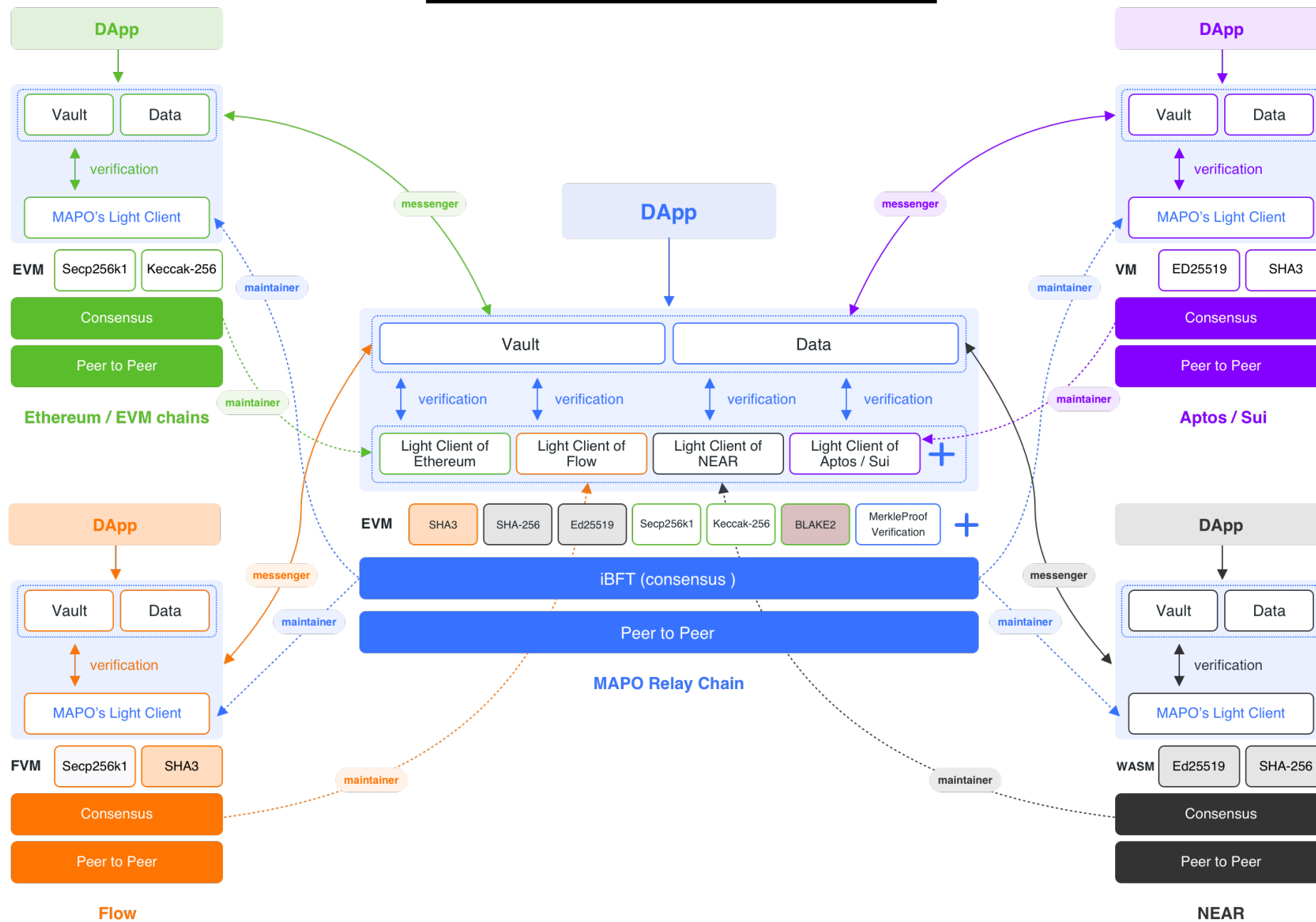

Technical Structure in Detail - Three Layers

Application Layer

- Assets and data from dApps assembly on MAPO Relay Chain
- DApps can achieve interoperability because of MAPO Service (MOS)
- The finality of omnichain data and asset verification network by MAP Protocol Layer empowers dApps to grow limitless.

MAPO Services Layer (MOS)

- Facilitate dApp developers to build applications, similar to Google Mobile Services to Android ecosystem.
- Consists of Vaults and Data deployed on each chain, and Messenger Program to transmit messages between chains.
- The execution layer for omnichain asset and data.
- DApp developers can build their components or use MOS.
- Developers can utilize Vaults and Data in MOS and share Vaults and Data liquidity with other applications.
- Messenger Program is an SDK deployed, operated, and maintained by dApp developers. DApp developers can also independently and flexibly incentivize messenger contributors for transmitting omnichain messages for the dApp.
- The self-verification mechanism of the Light-client on the MAP Protocol Layer assures the invalidity of malicious attacks from messengers.

Protocol Layer

- CORE of Omnichain Network Infrastructure: Verification Finality Network and dApp Deployment

- Consists of: MAPO Relay Chain, Light-Client deployed on each chain, and inter-chain Maintainer Program to update and maintain Light-Client status.
- MAPO Relay Chain proactively extends and supports heterogeneous blockchains' features in virtual machine, which construct a gas-efficient Light-Client verification network.
- Light-Client deployed on each chain has the characteristics of independent self-verification and verification finality, which becomes the verification network for cross-chain assets and data.
- The Maintainer is an independent inter-chain program responsible for updating the status of Light Clients. The mechanism of the Light-client assures the invalidity of malicious attacks from maintainer.
- MAP Protocol is this Layer in the narrow sense.
- MAP Protocol incentivizes validators on MAPO Relay Chain and Maintainers for updating Light-Client status.

Applications

- Fungible Token Bridge
- NFT Bridge
- Omnichain Swap
- On-chain Oracle
- Derivatives
- Omnichain DAO
- Omnichain Lending
- Omnichain Gamefi

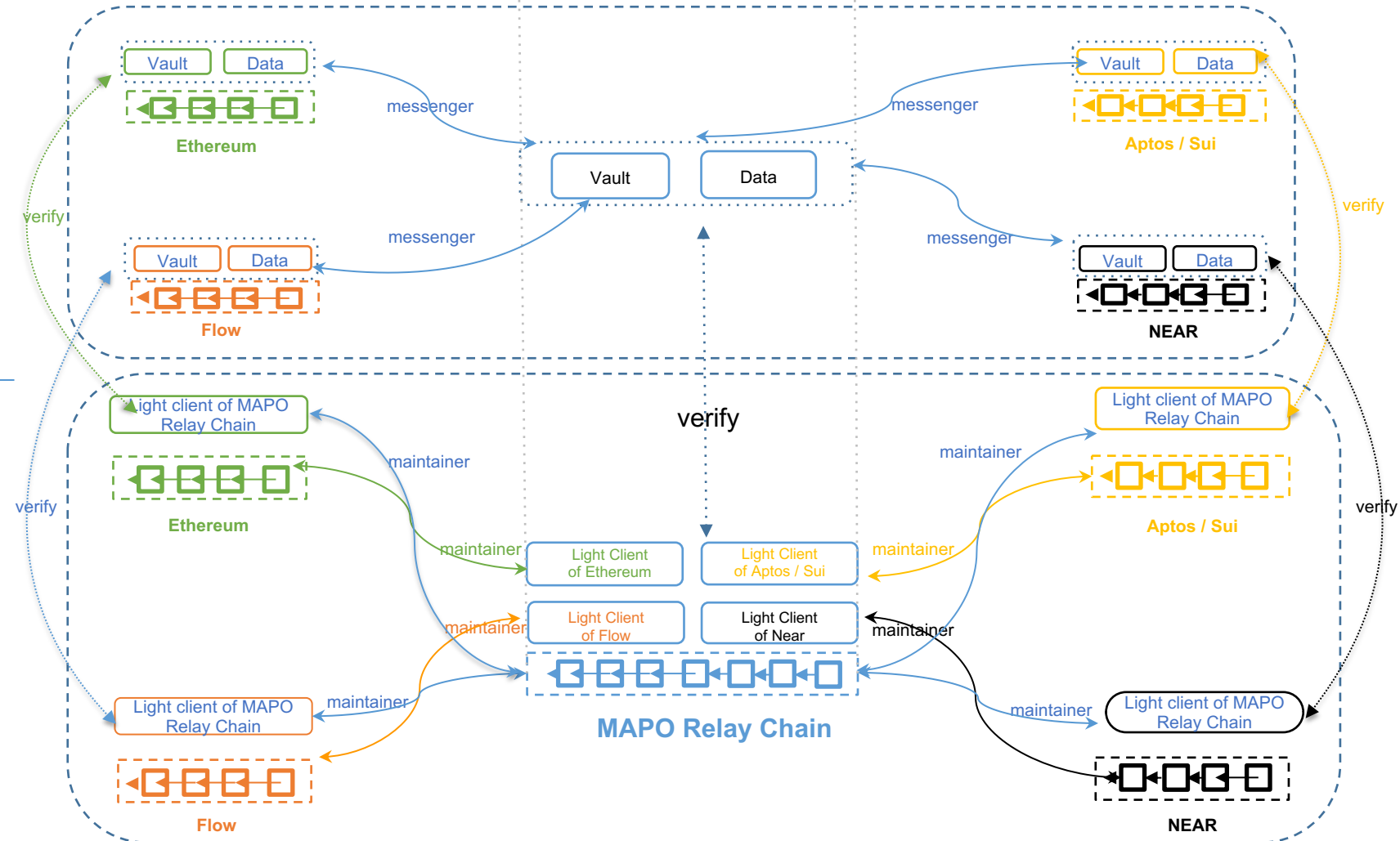

MAP Protocol Layer: MAPO Relay Chain's Underlying Layer Isomorphism with All Chains

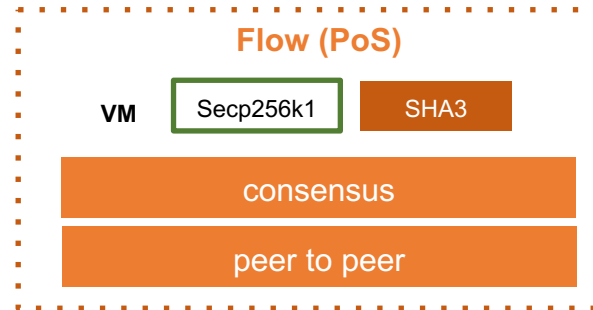
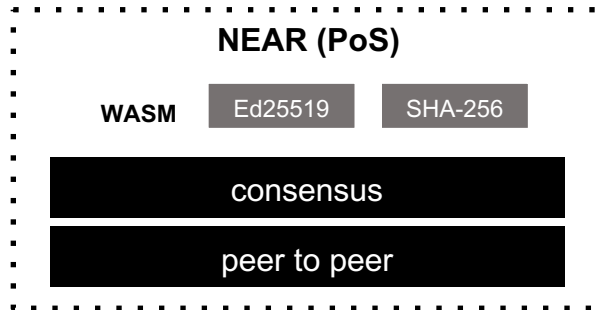
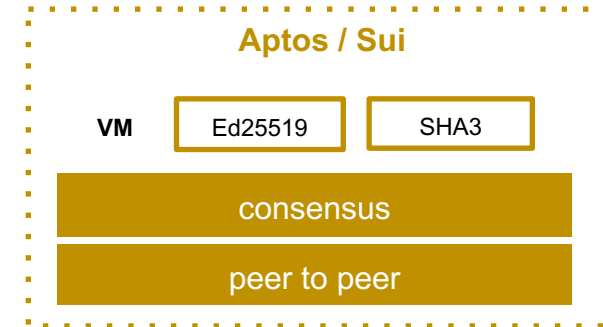
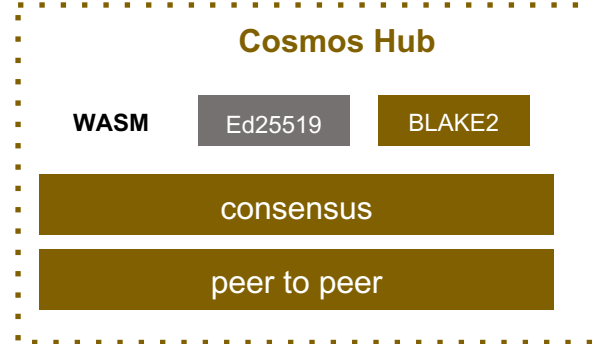
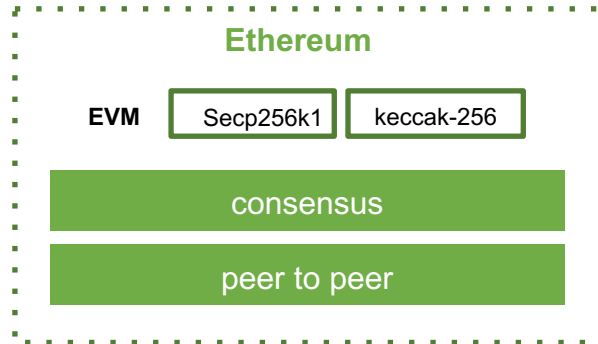

MAP Protocol extends the EVM layer of the MAPO Relay Chain by embedding each destination chain's algorithm as pre-compiled contracts to facilitate the light-client construction.

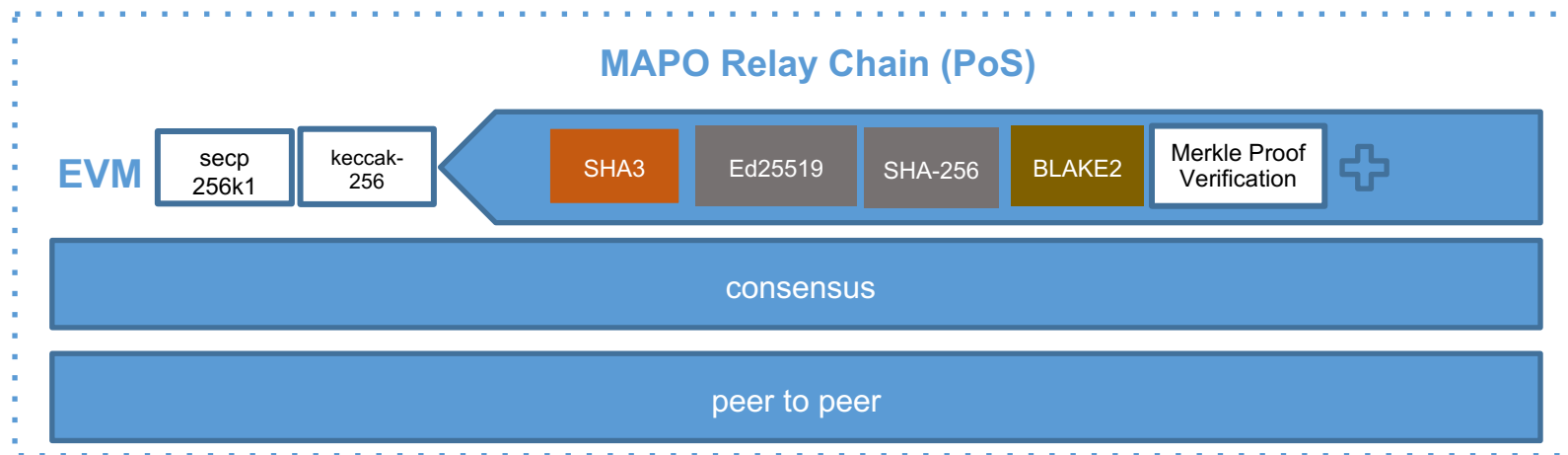

MAP Protocol's Verification & Maintenance Network

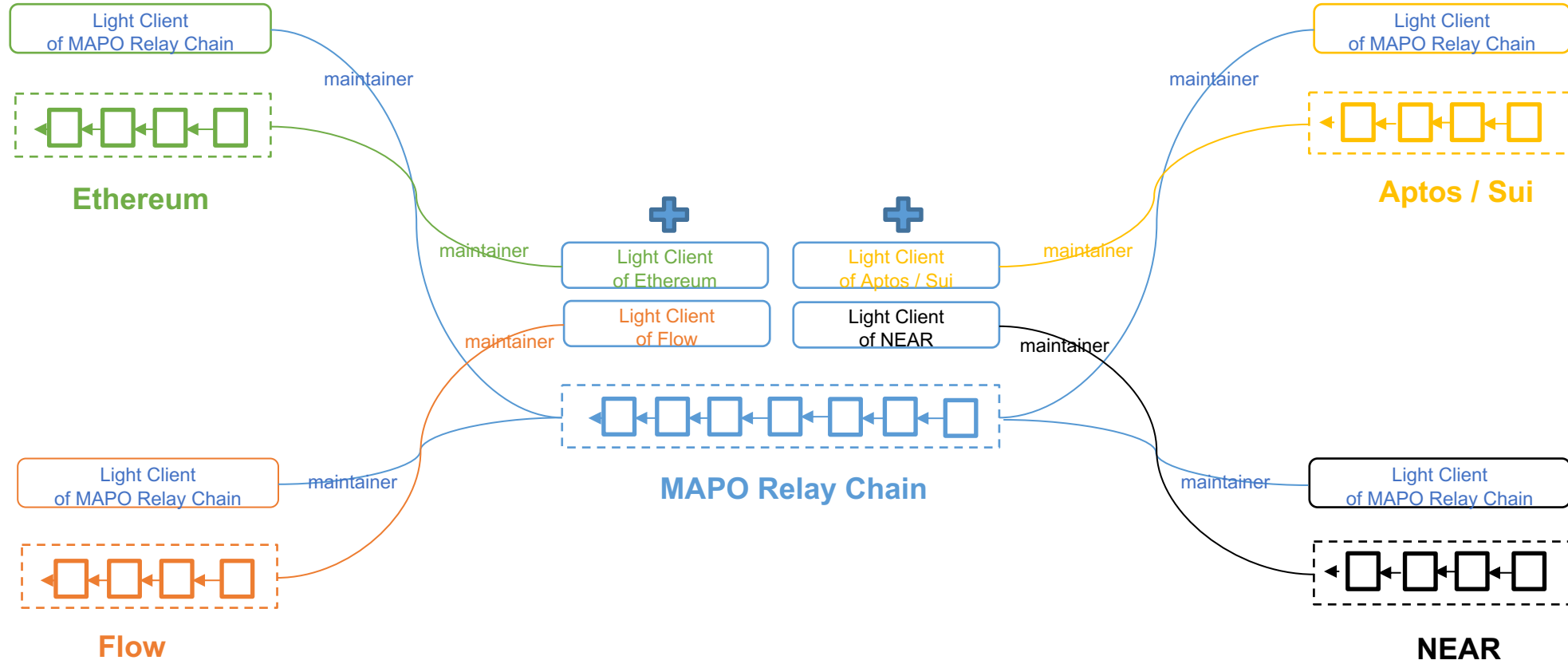

PoS Chain's Light-Client deployed on other chains:

- Store validators' public key and vote weight - no need to store block header.
- Verify new set of validators (authorized by the previous set) and self-update.
- Proof of certain txs or events: inclusion Merkle proof and corresponding block header info (contains signatures).
- Maintainer: Prepay the gas fees with Light-client updating for MAP Protocol and get rewards from MAP Protocol

PoW Chain's Light-Client deployed on other chains:

- Store latest N block headers.
- Verify new block header following consensus protocol and self-update.
- Proof of certain txs: inclusion Merkle proof.
- Maintainer: Prepay the gas fees with Light-client updating for MAP Protocol and get rewards from MAP Protocol

MAPO Services (MOS) Layer

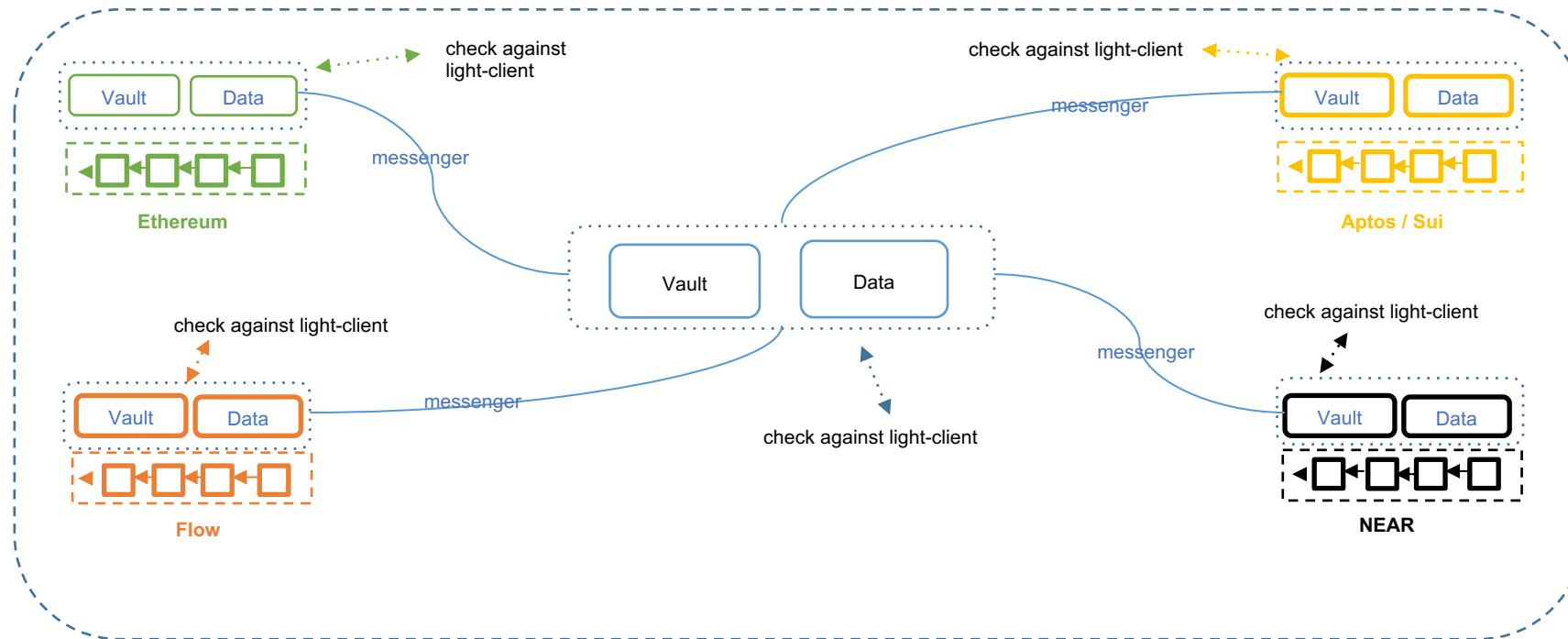

Messenger

- What is Messenger? Messenger is an independent inter-chain program. Messenger listens to relevant events as preset in the program and builds a proof on the ledger of the source chain; then transmit the message of the event and proof to Vault or Data on the destination chain.
- Messenger needs to prepay the gas fee of MAPO Relay Chain and the destination chain for omnichain users and thus get rewards from applications.
- As gas fees of destination chains cannot be estimated, MAP Protocol Layer cannot include this process into the bottom network because of the principle of absoluteness adopted by MAP Protocol.
- The flexibility of applications opens up many possibilities for Messenger, where applications can charge omnichain users flexible transaction fees and reward Messenger accordingly.
- As a main component of MOS, Messenger SDK is open to dApp developers.
- Messenger is a high concurrency inter-chain program. Theoretically, as long as one honest Messenger is working in between chains, all cross-chain transactions messages of the dApp can be transferred.
- Malicious attacks by messengers will not cause the loss of assets and will only result in invalidity of verification on the MAP Protocol Layer.

Vault & Data:

- On the source chain, Vault & Data are responsible for receipt of assets or data and trigger an event for Messengers to listen to.
- On relay chain or destination chain, Vault & Data are responsible for receiving cross-chain messages transmitted by Messengers, then through an internal component - router to schedule and conduct the verification of cross-chain transactions via Light-Client of the source chain deployed on destination chain. When verification completes, Vault & Data will record the corresponding instruction.
- dApp developers can deploy vault & Data. They can also share the liquidity of asset vaults or data pools via MOS Vault & Data.

How does Light Client works in MAP Protocol

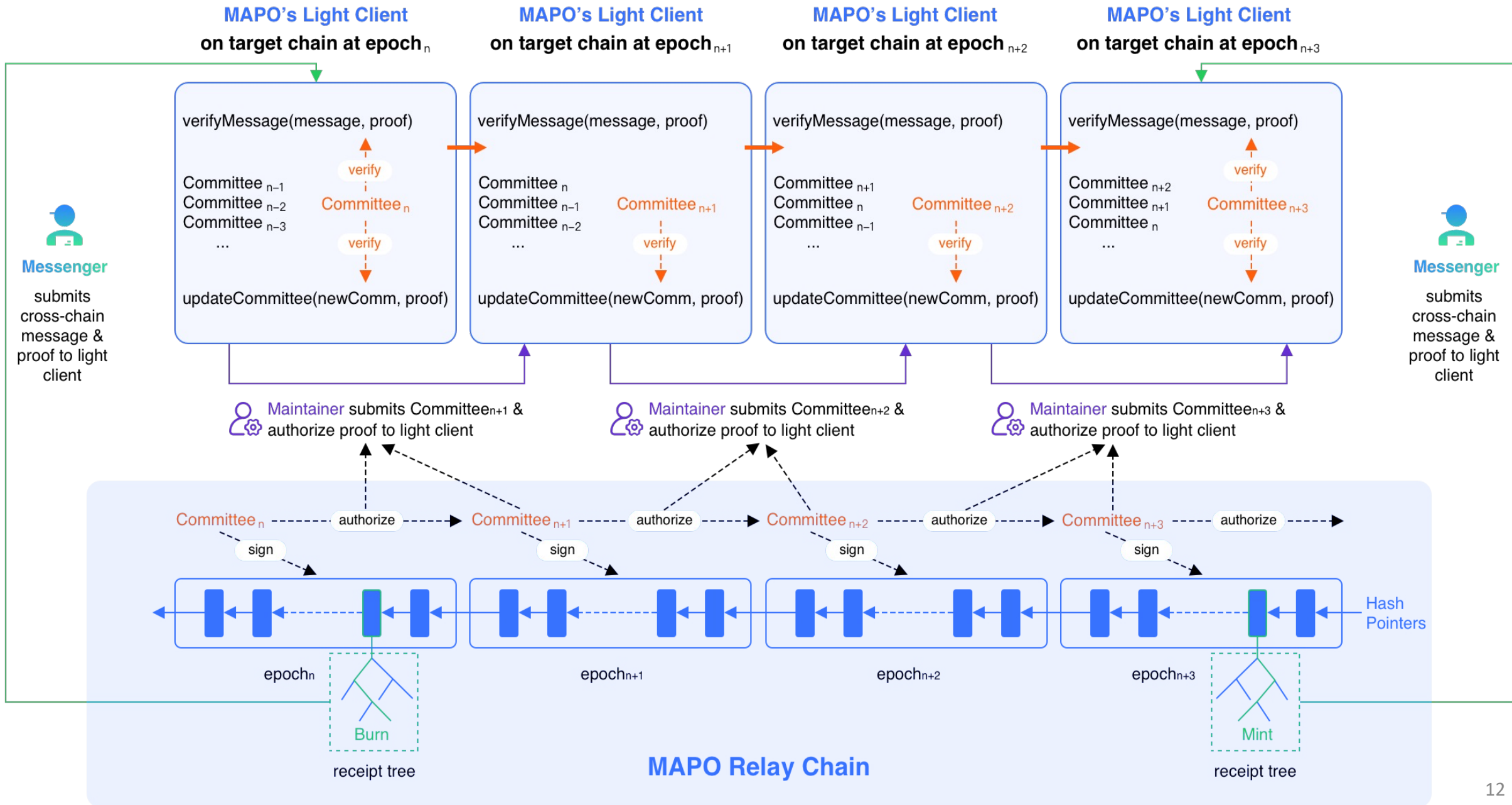

Refactor Light-Client With Zero-Knowledge Technology

- **Light clients in MAP Protocol are constructed as bulletproof smart contracts on MAPO Relay Chain and all connected blockchains**
 - While transparency and decentralization are well preserved with on-chain smart contracts, gas consumption is non-negligible
 - With the recent development of zkSNARK, the foundation of MAP Protocol, light client construction and cross-chain proof verification can be reshaped
 - Correctness of light client's state transition is vital to MAP Protocol as it determines the validation of cryptographic proof for cross-chain message
- **Current light-client and cryptographic proof construction for PoS + BFT chains, as of MAPO Relay Chain**
 - Light client tracks latest validator set, as new validator set is normally authorized by the old one, light client checks that the new one is approved via enough signatures
 - Cryptographic proof for an event includes the Merkle proof of the event in the receipt tree as well as the corresponding block header
 - Proof check: check the block header is signed by enough validators, then check the Merkle proof against the Merkle root carried by the block header
- **Current light-client and cryptographic proof construction for PoW chains, as of Ethereum**
 - Light client tracks latest block headers, the hash link and accumulated work are checked for new block headers submitted to the light client
 - The cryptographic proof of cross-chain message for an event is just the the Merkle proof of the event in the receipt tree
 - Proof check: check the Merkle proof against the Merkle root carried by the corresponding block header, that is maintained by light client
- **With zk technology, both the light-client construction and proof check process can be improved**
 - Signature check, Merkle proof check against certain Merkle root, as well the hash link and accumulated work check are all suitable to be certified via zkSNARK
 - On the light client construction side, instead of store tons of validator set info or block headers, a simple commitment should be enough
 - The commitment is about the validator set (PoS) or latest block header set (PoW), and each time the set change, the commitment is updated
 - Here we employ the zkSNARK to prove that the change from old commitment to new commitment reflects a valid change of validator set or block header set
 - E.g., in PoS setting, it means that the new validator set related to the new commitment stored in the light client is valid regarding to the old set related to the old commitment
 - The constraints imposed by zkSNARK mainly includes checking that enough old validators have approved the new set and the voting weight passes a certain threshold
 - Basically, the complexity is dealt with inside the zkSNARK constraints where the smart contract implementation is freed from the scary details.
- **Similar ideas by Celo project, aka. the PLUMO ultralight blockchain client, but MAP Protocol has a different goal**
 - PLUMO utilizes two specialized curves, aka BLS12-377 and BW6, to realize a recursive style zkSNARK to gain better efficiency
 - The curve selection fits the need of PLUMO's goal, to enable light client running on smart phones
 - Yet, with MAP Protocol, we are trying to connect with more blockchains via smart contracts and these two specialized curves contradicts our goal
 - With MAP Protocol, we are trying to find the greatest common divisor among all blockchains and hence we prefer the BN256 curve which is already widely adopted in EVM world
 - We are still exploring the idea listed above to find the proper balance between the engineering difficulty, gas consumption, off-chain computation resource required, etc.

MAP Protocol Omnichain Application - Fungible Tokens Bridge

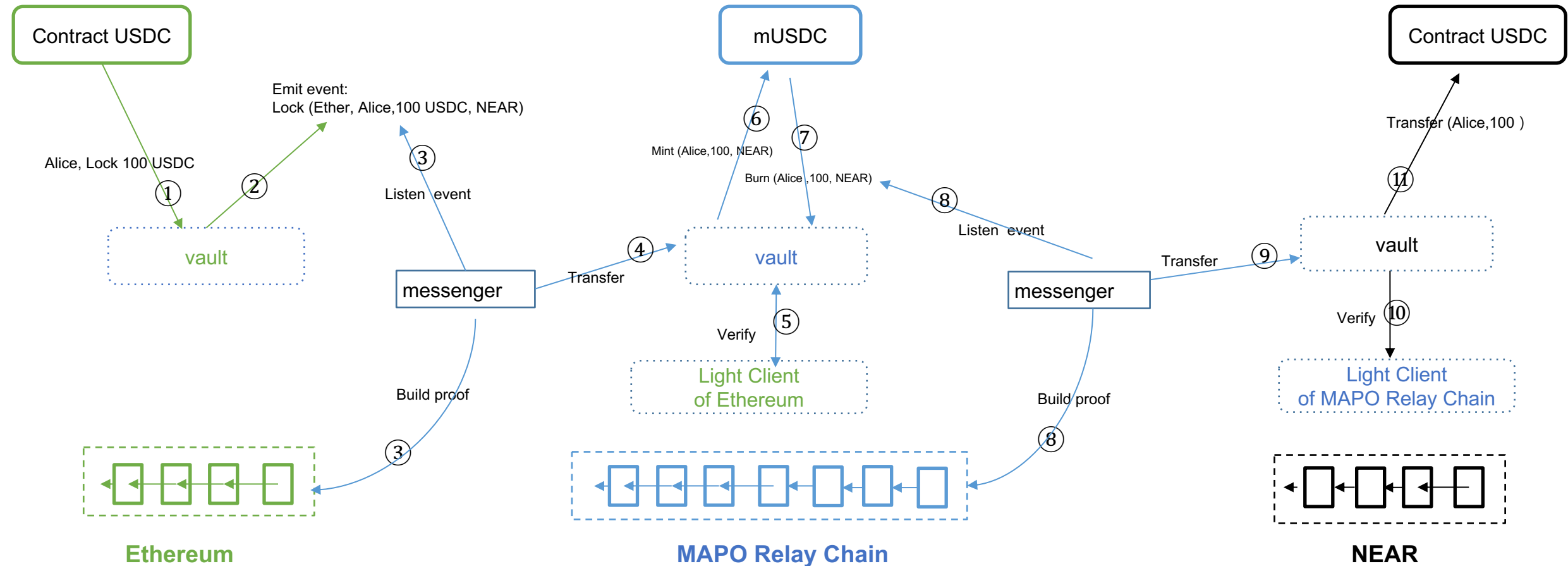

*Fungible tokens like USDC are issued simultaneously on multiple chains. Dapp developers need to submit whether fungible tokens are issued on multiple chains on the MOS' vault to avoid different forms of the same assets created during the cross-chain process.

MAP Protocol Omnichain Application - NFT Bridge

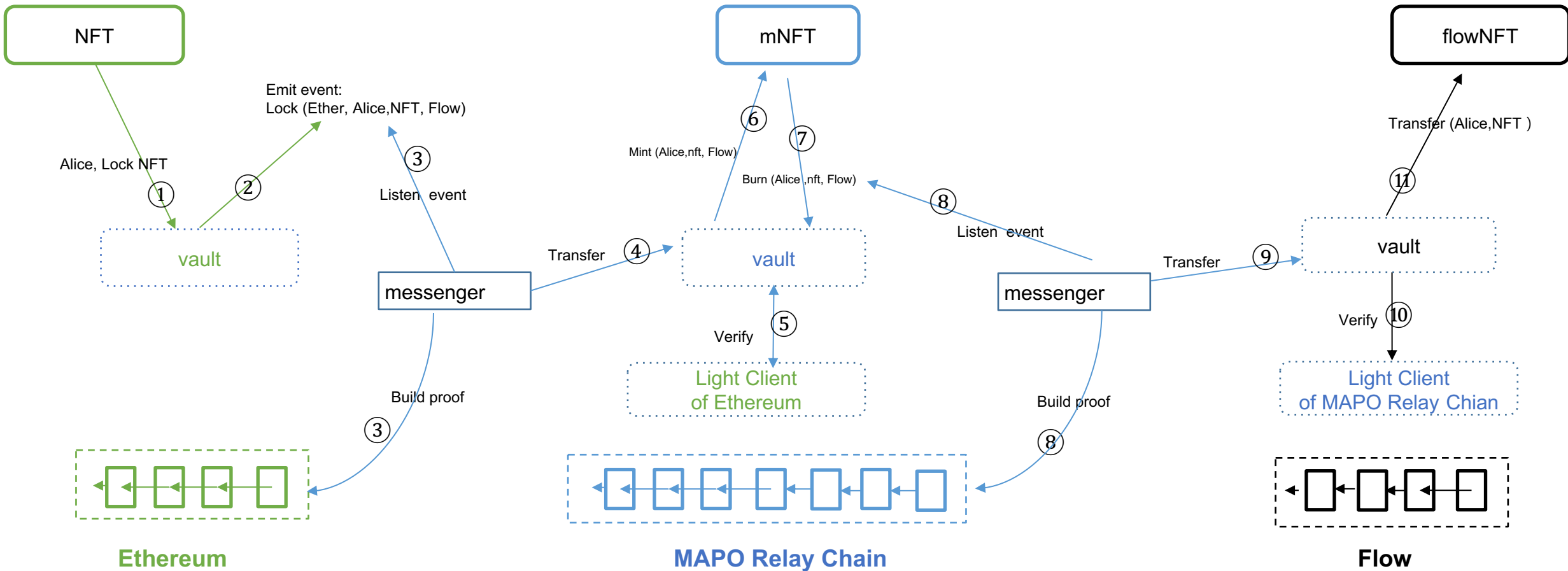

MAP Protocol Omnichain Application - Data

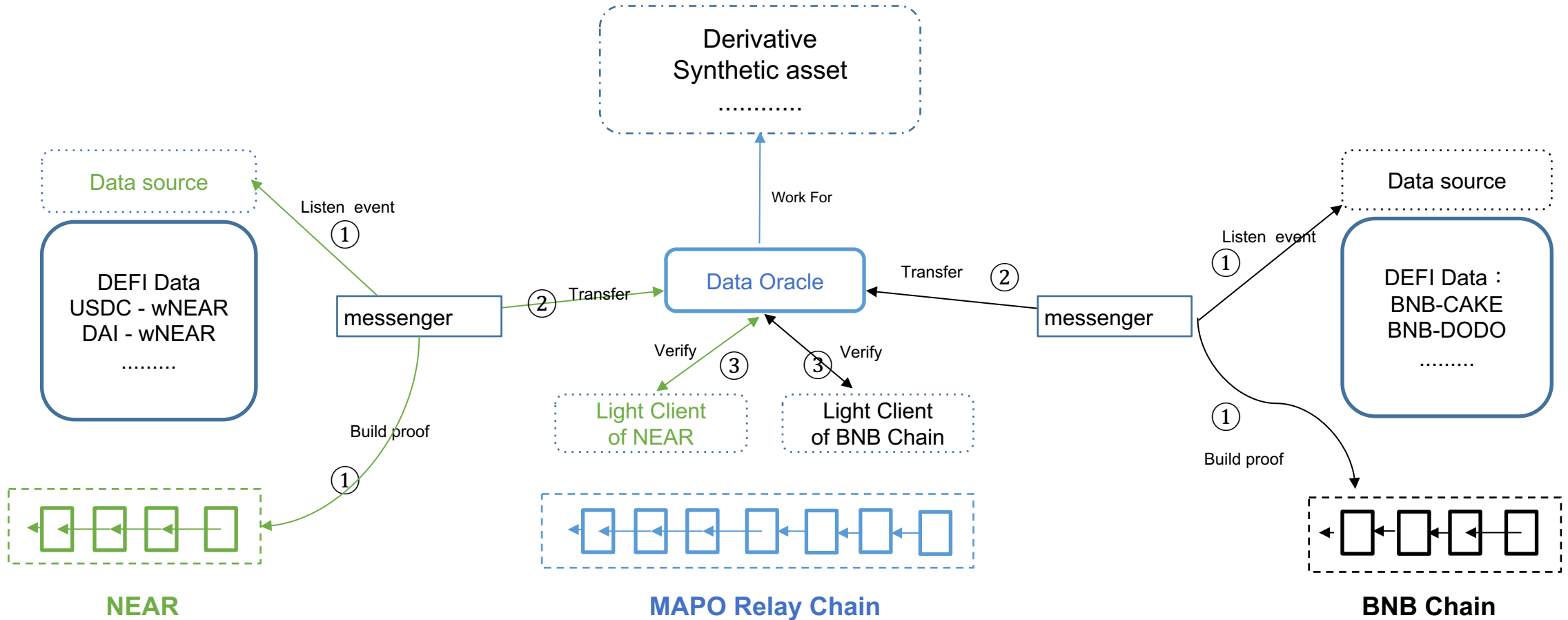

Decentralized derivative and synthetic assets are usually constrained by the accuracy and timeliness of asset prices, and quantities originated from other chains. This issue can be solved by deploying on multiple chains but is extremely complex. By building a reliable omnichain network, MAP Protocol has enabled Data cross-chain and is nurturing a completely new oracle market - **On-Chain Oracle**. By deploying on MAPO Relay Chain, derivative and synthetic asset applications can acquire reliable multi-chain data from On-Chain Oracle with ease.

Detail Comparisons: MAP Protocol vs. Cosmos & Polkadot

Technical Mechanism	Cosmos & Polkadot	MAP Protocol
Similarities	<ol style="list-style-type: none"> 1) Interoperate with other chains through relay chain. 2) Verification Finality of omnichain assets and data through Light-clients. 3) Omnichain interoperability is achieved through modules including light-client, cross-chain messaging system, and cross-chain assets and data management. 	
Differences	<ul style="list-style-type: none"> • The relay chain does not support cross-chain between EVM and other heterogeneous chains. EVM and other heterogeneous chains need to modify the in-chain structure to become compatible. • Require EVM and other heterogeneous chains to embed the SDK to the bottom layer of the blockchain. The SDK contains cross-chain execution and verification programs such as Light-clients, asset and data management system, and cross-chain messengers. • After embedding the SDK, the modified chains become interconnected with the relay chain, thus forming a cross-chain network. 	<ul style="list-style-type: none"> • MAPO Relay Chain expands to all heterogeneous chains proactively by adding other heterogeneous chains' signatures, hashes, mining, and Merkle proof calculation to the EVM level. • Proactively deploy the cross-chain execution and verification components on-chain or inter-chain, including assets and data management, cross-chain messengers, and Light-client for verification by way of smart contracts on-chain or inter-chain programs. • Every chain is naturally interoperable with MAPO Relay Chain, thus forming an omnichain network.

	Asset Management	Cross-chain Verification	Security	Security in Details
Thorchain	MPC	MPC Node Self-verification	Lowest	<ul style="list-style-type: none"> • MPC nodes are responsible for managing cross-chain assets and verifying the cross-chain validity of cross-chain transactions. • MPC nodes are vulnerable to cyber-attacks.
Multichain				
Celer	MPC & PoS	MPC Node Self-verification	Low	<ul style="list-style-type: none"> • With PoS, MPC nodes are rotated based on certain mechanisms and required to stake tokens to reduce the risk of embezzlement. • Off-chain ledger and MPC nodes are still vulnerable to cyber-attacks.
Axelar				
Layerzero (Stargate)	Non-custodial	Oracle Verification	Non-finality	<ul style="list-style-type: none"> • Oracle verification is ambiguous and not final. • Oracle requires asset staking, which reduces the risk of cheating. • The risk of oracle colluding with messengers always exists.
MAP Protocol	Non-custodial	Light-client Verification	Finality	<ul style="list-style-type: none"> • Light Client adopts mature SPV technology, an independent self-verification mechanism without any security blind spots.

- The above lightweight solutions, including MAP Protocol, achieved cross-chain functionality by deploying cross-chain communication components on-chain or inter-chain, which are better solutions than Cosmos & Polkadot (require embedding SDK to the bottom layer of the blockchain);
- MPC (Multi-Party Computation) technology is easy to develop but has obvious security risks.
- Using Oracle to conduct cross-chain verification is ambiguous, and the risk of colluding with messengers always exists.
- Using Light-client to conduct cross-chain verification is the ultimate security mechanism adopted in MAP Protocol, Cosmos, and Polkadot.
- The Light-client verification mechanism will lead to massive consumption of gas fees for cross-chain activities between heterogeneous chains. The better way is to use a relay chain, compatible with multiple chains' algorithm, thus enabling a homogeneous cross-chain and forming the ultimate cross-chain verification network. MAP Protocol has developed the MAPO Relay Chain as such.
- As the cross-chain asset and data assembly, MAPO Relay Chain supports the native deployment of omnichain dApps, including cross-chain bridge applications, differentiating MAP Protocol from all the other competitors.

Tokenomics

Initial token supply of \$MAP tokens: **10,000,000,000**

Group	Ratio	2023				2024					2025	
		March	April	May	June	June	July	Aug	Sept	Dec	Jan	June
Team	15%	50,000,000	50,000,000	50,000,000	50,000,000	100,000,000	100,000,000			200,000,000	200,000,000	50,000,000
Foundation	12%	100,000,000	100,000,000	100,000,000	50,000,000	200,000,000	100,000,000	100,000,000	100,000,000			
Ecosystem DAO	21%	<p>This Ecosystem removes the previous released 3.11% of 21%. The remaining 17.89% will form a DAO Treasure, used for developer incentives, cross-chain vault incentives, marketing and community incentives, etc. It will be released through DAO governance, and community members can participate in voting through community proposals. Participate and earn part of the tokens and share the benefits.</p>										
Institutions and Partners	22%	<p>Released by 1% p.a. for the first 2 years, then 2% for the next 14 years.</p>										
Mining	30%	<p>Based on the actual progress of the investment and cooperation. Relevant information will be disclosed in the official media.</p>										

Anticipated \$MAP Unlocking Schedule for the Next 15 Years

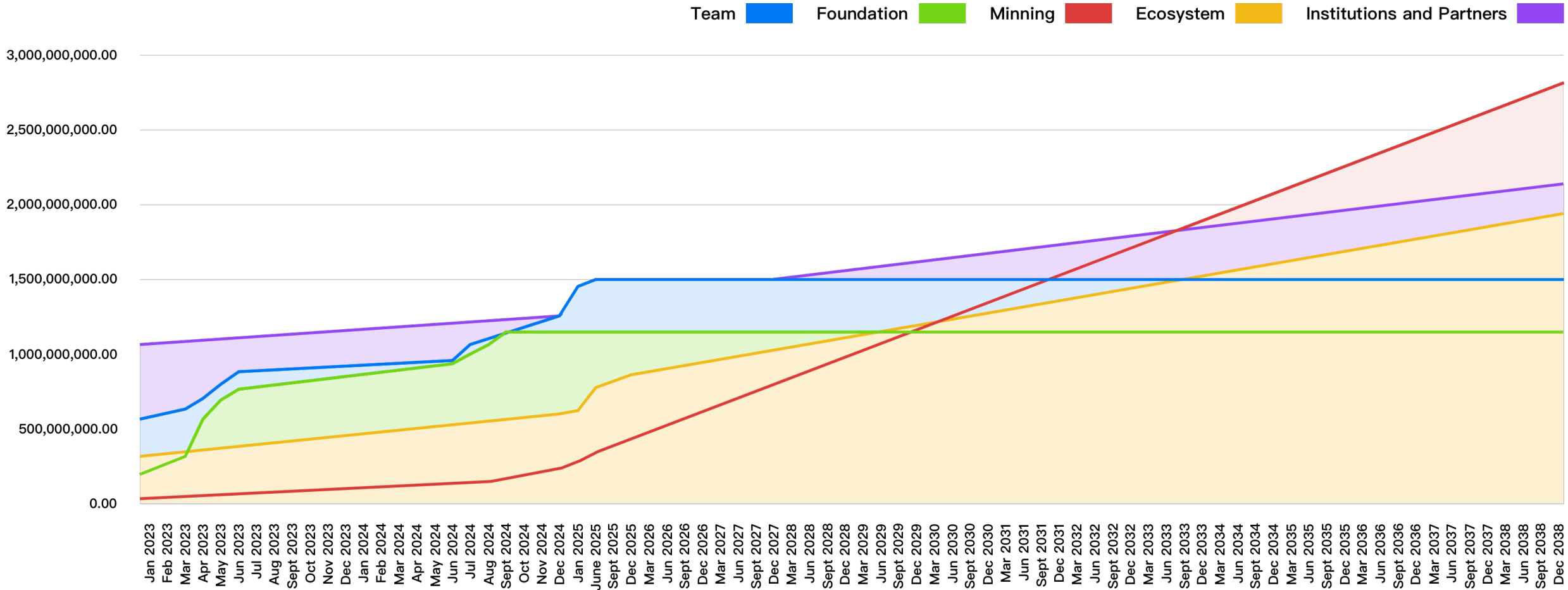

Both unlocked (i.e. tokens that are available for distribution) and locked (i.e. not available for distribution) tokens can be staked
 Anticipated Total Circulating Token Supply for the next 15 years subject to network performance and staking assumptions.

MAP Protocol's Fee Model

- As an omnichain network infrastructure designated for omnichain dApps, MAP Protocol is destined to nurture a prosperous ecosystem for as many \$MAPO users as possible. The critical success factor for MAP Protocol is to implement a simple yet cost-optimized revenue model.
- MAP Protocol will **only charge the gas fee produced on MAPO Relay Chain for each cross-chain transaction.** Maintainer can get extra rewards from MAP Protocol for updating and maintaining Light-Clients.
- As an inter-chain messenger program, Messenger is an essential part of MOS. Messenger needs to prepay the gas fees of MAPO Relay Chain and the destination chain for omnichain users, which cannot be estimated in a decentralized way. Thus MAP Protocol opens the Messenger SDK to developers. Application Layer provides the flexibility for dApp developers to determine the cross-chain transaction fee standard, rewards to messengers, and their entry requirements.
- Vault & Data deployed on each chain are also essential parts of MAPO Service (MOS), responsible for managing assets (fungible tokens and NFTs) and data on each chain. For developers of Vault & Data, MOS will not charge any fees. Applications can determine the fee structure for sharing the liquidity in vaults and data pools at their discretion.

Construction of MAP Protocol

MAP Protocol Layer

- **Validator:** Validator is the foundation of the MAPO Relay Chain. Community members can stake \$MAPO and build a node with the required computing power to run a validator. Community members can also delegate their \$MAPO to other validator operators.
- **Maintainer:** The value of the maintainer is to update the status of the Light-client deployed on the target chain so that the verification network can run smoothly. When the maintainer updates the Light-client, a transaction must be written on-chain, resulting in a gas fee payment. Because of this, MAP Protocol's economic model has designed a portion separately to incentivize and compensate Maintainers. Running as a maintainer requires computation power, sufficient fund flow to prepay the gas fees with the target chain's token, and staking of \$MAPO.

MAPO Service (MOS) Layer

- **Liquidity provider:** Community members can provide liquidity to Vaults on each chain through dApps deployed in the MAPO ecosystem. Incentives are provided directly by each dApp.
- **Messenger:** Running as a messenger requires sufficient amount of gas fee for the MAPO Relay Chain (\$MAPO) and the target chains (native token). Messengers are incentivized by each dApp.

MAPO Application Layer

- **dApp developers:** developers can build various omnichain dApps using MAPO's SDKs.

Areas of Applications (I)

Cross-chain Lending

Currently, if a user has money on chain A but wants to farm on Chain B, the user would have to go through 9 steps:

Collateralize on Chain A → borrow → bridge (fee) → swap (fee) → farm on the destination chain → swap back (fee) → bridge back (fee) → repay the loan → un-collateralize.

With MAP Protocol, you can collateralize on Chain A, borrow on the destination chain, farm, repay, and the collateral is unlocked, skipping the four bridging and swapping fees.

Omnichain Swap

Omnichain Swap allows you to swap coins with substantially lower fees than traditional DeFi exchanges by connecting you to the best cross-chain DeFi protocols. By using MAP Protocol, developers can build a truly decentralized omnichain exchange that enables users to swap any token on any chain.

Omnichain SWAP also enables omnichain aggregation swap by connecting every major DEX liquidity out there. Existing AMMs can be wrapped to perform omnichain swaps from one asset to another without the need to modify any existing code. User's will be able to swap from ETH on Ethereum to Near on Near in one single transaction from the source chain.

In an omnichain swap built with MAP Protocol, users can add multichain coin liquidity in one pool, that means providing liquidity to a pair of tokens from different chains becomes possible. Users can swap one token directly for another chain token from a different chain without using any intermediate token, such as stable coins, to achieve the shortest route of omnichain swap.

Butter Network, the first truly decentralized cross-chain exchange that enables users to swap any token on any chain, includes all the above functionalities and will be released in Q4 2022.

Areas of Applications (II)

Omnichain GameFi

As the crypto industry and the idea of metaverse boomed, a lot of innovative ideas were brought to the traditional gaming sector. Gaming Finance refers to the gamification of financial systems to create profit through participation in play-to-earn crypto games. The play-to-earn games are different from conventional games since players participate to earn rewards, and players can create in-game assets with complete control over ownership.

The lifespan of a GameFi depends heavily on the popularity and user's gaming experience. To maintain popularity, a new source of players is the key, and the best way is to expand to other chains so that users from other chains can participate. With MAP Protocol, GameFi Projects can deploy their tokens on multiple chains and allow users from other chains to efficiently and securely transfer their assets to their project's chain. For example, an BSC GameFi project deployed its tokens on Polygon and WAX chains; Users from Polygon and BSC can transfer their assets to WAX through the cross-chain bridge and participate in the GameFi, increasing the user base exponentially.

Another way to be scalable and maintain a good gaming experience is directly deploying on MAPO Relay Chain. With MAPO Relay Chain's interoperability, GameFi projects can automatically link up with all EVM and non-EVM chains efficiently and securely by deploying on MAPO Relay Chain. MAPO Relay Chain will proactively connect with all of the upcoming chains so that the GameFi project can focus on user experience without worrying about scalability and security problems.

On-chain Data: On-chain Oracle and Derivatives

Decentralized derivative and synthetic assets are usually constrained by the accuracy and timeliness of asset prices and quantities originating from other chains. This issue can be solved by multi-chain deployment, but it is extremely complex. By building a reliable omnichain network, MAP Protocol has enabled Data cross-chain and is nurturing a completely new oracle market - On-Chain Oracle. By deploying on MAPO Relay Chain, derivative and synthetic asset applications can easily acquire reliable multi-chain data from On-Chain Oracle.

Areas of Applications (III)

Omnichain Governance - The case of Aave

As told by its developers, a proposal executed on Aave, which is built on the Ethereum (ETH) network, was sent to the Polygon (MATIC) FxPortal. The mechanism then read the Ethereum data and passed it for validation on the Polygon network. Afterward, the Aave cross-chain governance bridge contract received this data, decoded it and queued the action, pending a timelock for finalization. The development team wrote:

The Aave cross-chain governance bridge is built in a generic way to be easily adapted to operate with any chain that supports the EVM and cross-chain messaging. Currently, the repository supports contracts bridging to Polygon and Arbitrum. On Aave, users can submit Aave Improvement Protocols, or AIPs, to target various features on the DeFi platform.

With MAP Protocol's interoperability with all-chains, omnichain governance can be achieved with all EVM and heterogeneous chains by a security cross-chain infrastructure.

Fungible token and NFT Bridge

Cross-chain bridges and cross-chain NFT bridges no longer have to build their infrastructure or use MPC. Using MAPO's underlying cross-chain verification network with finality and the MOS application developer service kit, bridge developers can easily build their NFT or homogenized token bridge application.

References

- [1] Kan, Amjad Hafiz Muhammad, et al. "A multiple blockchains architecture on inter-blockchain communication." 2018 IEEE International Conference on Software Quality, Reliability and Security Companion (QRS-C). IEEE,2018. <https://ieeexplore.ieee.org/document/8431965>
- [2] Buterin Vitalik. "Chain interoperability." R3 Research Paper (2016). <https://allquantor.at/blockchainbib/pdf/buterin2016chain.pdf>
- [3] Nakamoto,S. . "Bitcoin: A Peer-to-Peer Electronic Cash System." (2009).
- [4] Gavin Wood. 2016. POLKADOT: VISION FOR A HETEROGENEOUS MULTI-CHAIN FRAMEWORK. <https://polkadot.network/PolkaDotPaper.pdf>
- [5] Sean Braithwaite, Ethan Buchman, Ismail Khoffi, Igor Konnov, Zarko Milosevic, Romain Ruetschi, Josef Widder. 2020. A Tendermint Light Client. <https://arxiv.org/pdf/2010.07031.pdf>
- [6] Ryan Zarick Bryan Pellegrino Caleb Banister " Δ : Solving the Bridging Trilemma." <https://www.dropbox.com/s/gf3606jedrmp61/Delta-Solving.The.Bridging-Trilemma.pdf?dl=0>
- [7] "THORChain: a decentralised liquidity network" <https://github.com/thorchain/Resources/blob/master/Whitepapers/THORChain-Whitepaper-May2020.pdf>
- [8] Chomtana Chanjaraswichai,"Bridges deep technical comparison + Axelar special use case (Axelar, cBridge, zkLink, Anyswap, Hop, Binance)" <https://medium.com/@chomtana001/bridges-deep-technical-comparison-axelar-special-use-case-axelar-cbridge-zklink-anyswap-hop-e901f9c67946>
- [9] Szydlo,Michael. "Merkle tree traversal in log space and time." International Conference on the Theory and Applications of Cryptographic Techniques. Springer, Berlin, Heidelberg, 2004.
- [10]Jae Kwon, Ethan Buchman. 2016. Cosmos Whitepaper. <https://github.com/cosmos/cosmos/blob/master/WHITEPAPER.md>
- [11]Maofan Yin, Dahlia Malkhi, Michael K. Reiter, Guy Golan Gueta, Ittai Abraham. 2019. HotStuff: BFT Consensus in the Lens of Blockchain. <https://arxiv.org/pdf/1803.05069.pdf>
- [12] Roberto Saltini and David Hyland-Wood. 2019. Correctness Analysis of Istanbul Byzantine Fault Tolerance. <https://arxiv.org/pdf/1901.07160.pdf>
- [13] Haas, Andreas, et al. "Bringing the web up to speed with WebAssembly." ACM SIGPLAN Notices. Vol. 52. No. 6. ACM, 2017. <https://css.csail.mit.edu/6.858/2022/readings/wasm.pdf>
- [14] Maurice Herlihy. 2018. Atomic cross-chain swaps. In Proceedings of the Annual ACM Symposium on Principles of Distributed Computing. Association for Computing Machinery, New York, New York, USA, 245–254. <https://dl.acm.org/doi/10.1145/3212734.3212736>
- [15]Chen, Zhi-dong , et al. "Inter-blockchain communication." DEStech Transactions on Computer Science and Engineering cst (2017).
- [16]XCMP overview. <https://research.web3.foundation/en/latest/polkadot/XCMP/index.html>
- [17] Roberto Saltini and David Hyland-Wood. 2019. IBFT 2.0: A Safe and Live Variation of the IBFT Blockchain Consensus Protocol for Eventually Synchronous Networks. <https://arxiv.org/pdf/1909.10194.pdf>
- [18] Ethan Buchman, Jae Kwon and Zarko Milosevic. 2018. The latest gossip on BFT consensus. <https://arxiv.org/pdf/1807.04938.pdf>
- [19] March 19, 2021,What Are Blockchain Bridges, and Why are they Important for DeFi? <https://blog.makerdao.com/what-are-blockchain-bridges-and-why-are-they-important-for-defi/>
- [20] Aave V3 Technical paper: https://github.com/aave/aave-v3-core/blob/master/techpaper/Aave_V3_Technical_Paper.pdf
- [21]Cross-chain governance and open-sourcing the Aave UI <https://medium.com/aave/cross-chain-governance-and-open-sourcing-the-aave-ui-ad9dd632175d>

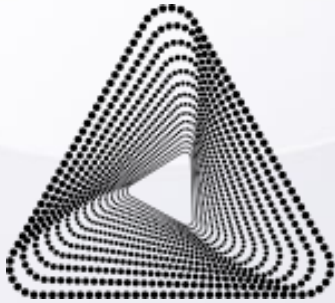

MAP PROTOCOL



Litebook: https://files.maplabs.io/pdf/mapprotocol_Litebook_en.pdf



mapprotocol.io



@MapProtocol



@MAPProtocol



<https://discord.com/invite/W3RnfZE6DV>



github.com/mapprotocol

